

Neato XV-11™ Vacuum User's Guide

READ ALL INSTRUCTIONS BEFORE USING THIS APPLIANCE.
SAVE THESE INSTRUCTIONS.
PLEASE REFER TO PAGE 10 FOR ADDITIONAL SAFETY INSTRUCTIONS.



1916 Old Middlefield Way Suite A
Mountain View, CA 94043

Copyright © 2009 Neato Robotics, Inc. All rights reserved.

Neato Robotics, Neato XV-11, and Your Future is Neat are trademarks
of Neato Robotics, Inc.

Table of Contents

Welcome!	5
Anatomy of Your Neato XV-11 Vacuum	6
Important Safety Instructions	10
Likes and Dislikes	11
Using the Neato XV-11 Vacuum	15
Using the Charging Base.....	16
Charging without the Charging Base	19
Charging Status	21
Optimal Charging.....	21
Cleaning Mode	22
Quick-Start Your Robotic Vacuum	23
Using the Control Center LCD screen	24
Setting the Clock.....	26
Scheduling a Cleaning	28
To Get the Most of Scheduled Cleanings	30
Ideas for Scheduled Cleanings	31

Removing a Scheduled Cleaning	32
Pausing a Cleaning	34
Turning off the Lights on Your Vacuum	34
Turning off Your Vacuum	35
Emptying the Dirt Bin.....	36
Boundary Markers	38
Using boundary markers.....	38
Communicating with Your Neato XV-11 Vacuum	39
LCD Feedback Messages	40
Filters	42

Customer Support 43

One Year Warranty (Domestic Use)	44
Compliance Information	45
Declaration of Conformity	46
Parts.....	49
Disposal Notices	50

Welcome!

Thank you for purchasing your new Neato XV-11 vacuum. And welcome to the home robotics revolution.

This detailed user's guide will provide all you need to know. It's easy.

If you are in a hurry, and want to learn the basics to get started right away, you can read the Quick Start Guide. It's even easier.

We're here to help.

If you need help or have any questions, please contact our Customer Service team at <http://www.neatorobotics.com/support>.

We want to keep in touch.

To ensure that we keep you up to date on your new Neato XV-11 vacuum, please register at <http://www.neatorobotics.com/register>.

Neato is developing robotic home maintenance products that promise to free everyone from the drudgery of household cleaning.

Your Future is Neat™.

Anatomy of Your Neato XV-11 Vacuum

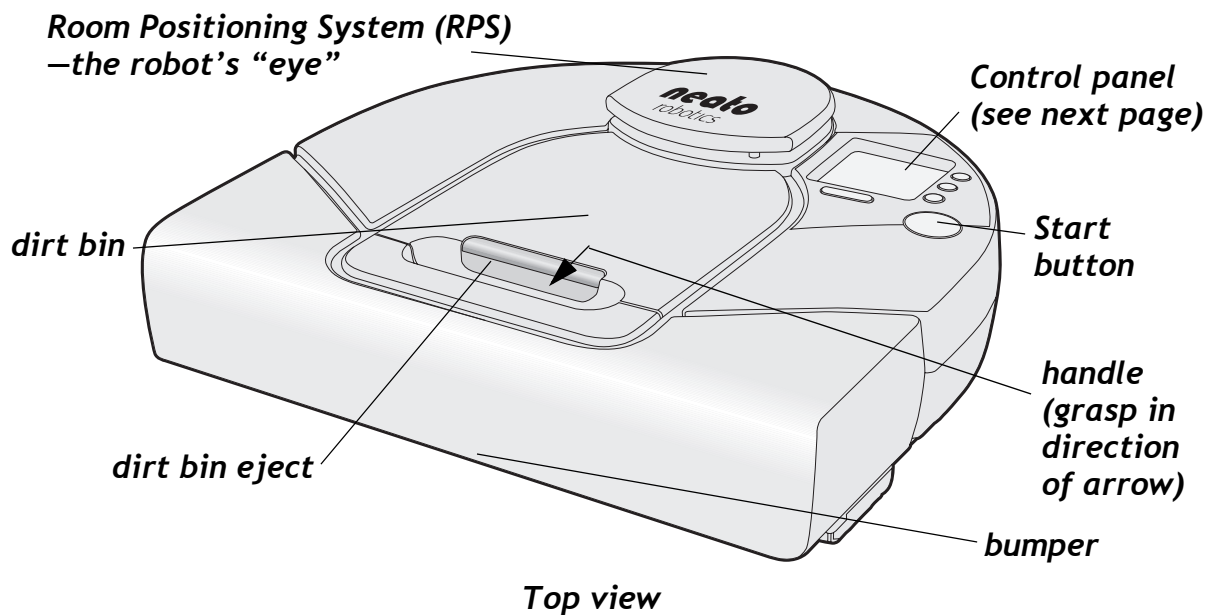

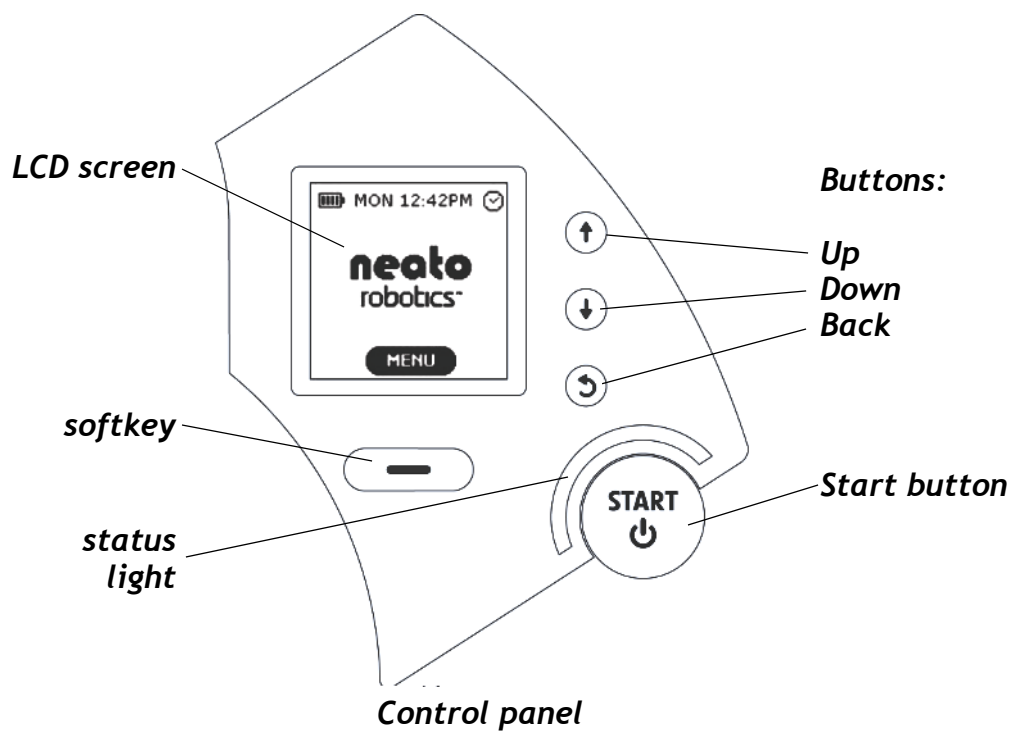

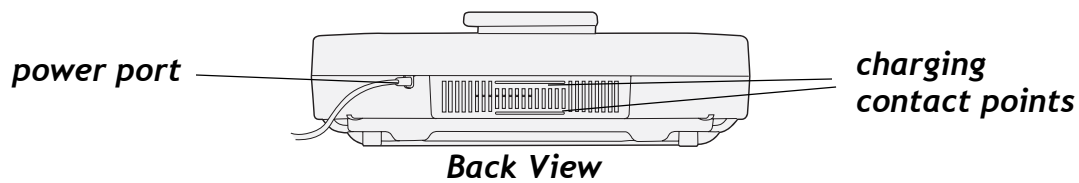
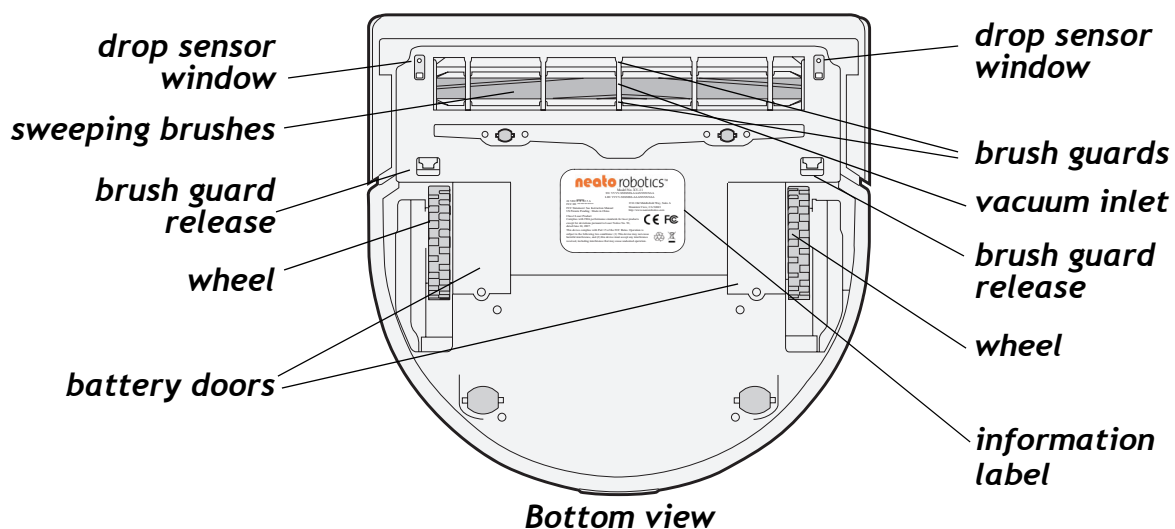

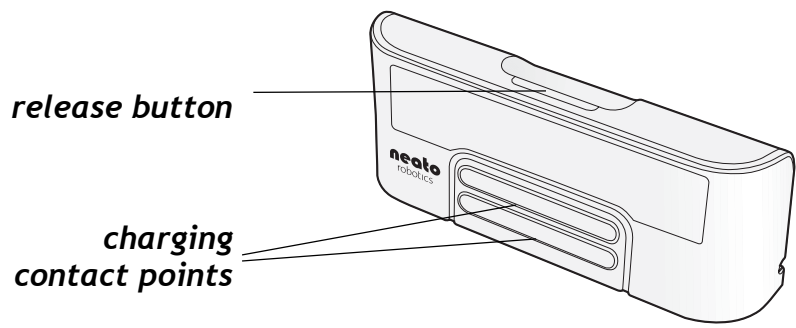

release button

charging contact points

Charging base (external view)

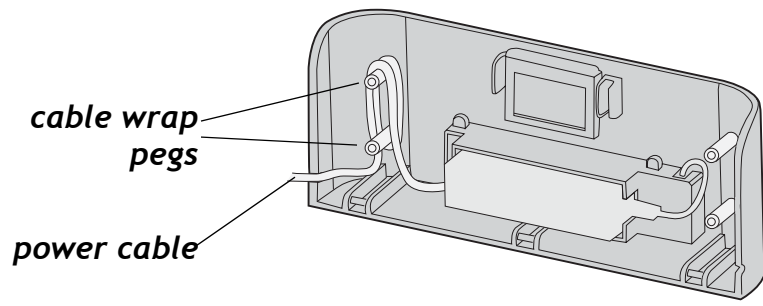

*cable wrap
pegs*

power cable

Charging base (internal view)

Important Safety Instructions

Please read all instructions before using this appliance.

Save these instructions for future reference.

Refer all non-routine servicing to Neato Robotics.

The robotic vacuum cleaner shall only be charged using the included power adaptor or charging base.

The robotic vacuum cleaner shall only be operated using the included batteries. Do not replace with non-rechargeable batteries. If your batteries run low, replacement batteries can be purchased at <http://www.neatorobotics.com/support>.

This appliance is not intended for use by persons (including children) with reduced physical, sensory or mental capabilities, or lack of experience and knowledge, unless they have been given supervision or instruction concerning use of the appliance by a person responsible for their safety. Children should be supervised to ensure that they do not play with the appliance.

For best performance, empty your dirt bin and clean the vacuum's brush after each use.

Likes and Dislikes

There are just a few things to remember that will keep your Neato XV-11 vacuum happy and successful in your home:

Likes	Dislikes
POWER. Charge it when you aren't using it to ensure that every time you need it, it will be ready to roll.	WATER, CHEMICALS, or OTHER MOLD PRODUCING FLUIDS. Do not clean wet messes with your Neato XV-11. Though it may seem pet-like, do not bathe or otherwise submerge your Neato XV-11 vacuum in water. It also doesn't like harsh chemicals, or anything that can permanently stain it. It doesn't mind being cleaned and groomed with a damp cloth, however.

Likes	Dislikes
<p>BOUNDARIES. Your Neato XV-11 vacuum likes to clean everywhere it can reach. If you want to keep the robot from a certain area, just put out the boundary markers (see page 38). The robot will clean up to the boundary markers but will not cross over the them.</p>	<p>HANGING CABLES AND LOW TO THE GROUND TABLECLOTHS. To keep your robot and your home safe, make sure that your vacuum cannot get caught on hanging electric cords, tablecloths, or other cord-like items.</p>
<p>GROOMING. Because it's down in the dirt all day long, your Neato XV-11 vacuum can get a little grungy. After a while, give it a once over to ensure wheels and brushes are free of hair and debris and to keep it running smoothly.</p>	<p>COLD. Exposing your Neato Robotics vacuum to freezing temperatures may cause permanent damage, and possibly hurt its feelings.</p> <p>OUTDOORS. Your Neato vacuum is a domestic device and not intended for outdoor use. Keep it in the house where it will be happy.</p>

Neato XV-11 vacuum cleaning smarts

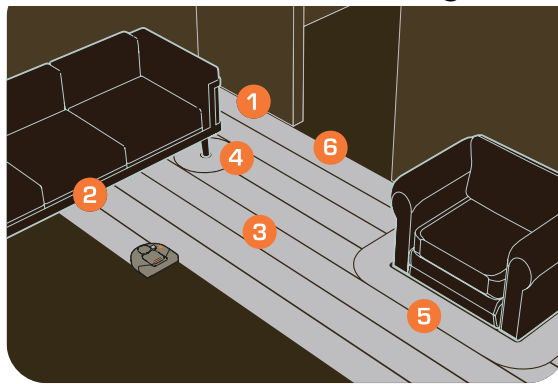

- 1- Rectangular front design allows vacuuming close to walls and into corners.***
- 2- Low profile allows cleaning under furniture.***
- 3- Always vacuums in straight lines.***
- 4 & 5- Cleans closely around obstacles.***
- 6- Automatic doorway recognition ensures complete cleaning of room before moving on to the next.***

Using the Neato XV-11 Vacuum

The Neato XV-11 vacuum is ready to start cleaning as soon as you charge up its battery.

- To charge the battery, see *Using the Charging Base* on page 16 or *Charging without the Charging Base* on page 19.
- To begin a quick-start cleaning, see *Quick-Start Your Robotic Vacuum* on page 23.
- To schedule regular cleanings, see *Scheduling a Cleaning* on page 28.

Using the Charging Base

Using the Charging Base

The Neato XV-11 vacuum has a preinstalled Nickel Metal Hydride (NiMH) rechargeable battery that has to be fully charged before you can use it for the first time.

You can use the charging base to charge it as described in the steps below, or plug the charging cable into the vacuum's power port as described in *Charging without the Charging Base* on page 19.

To use the charging base:

- 1 Plug your charging base into the wall and place it on the floor in a room:
 - that you want to vacuum frequently
 - at least 3 feet from a corner of the room
 - where the vacuum will have a clear path to return to recharge itself

Using the Charging Base

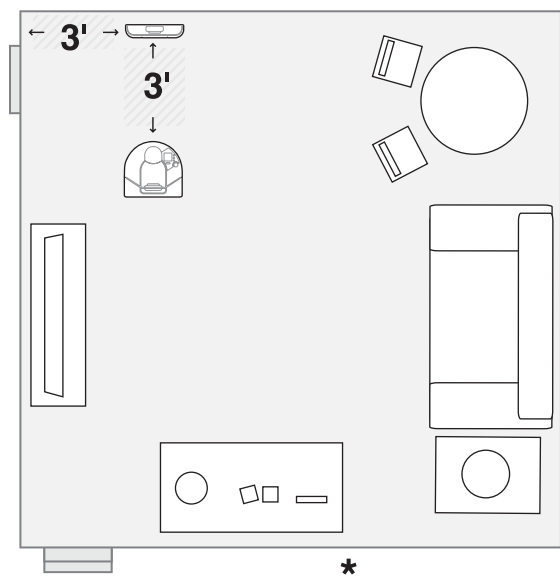

Giving the vacuum a clear path to its charger

Using the Charging Base

- 2 Place the Neato XV-11 vacuum's curved edge up against the charging base so that the charging base's contact points make contact with the vacuum's charging contact points. The status light turns on to show you it is charging.

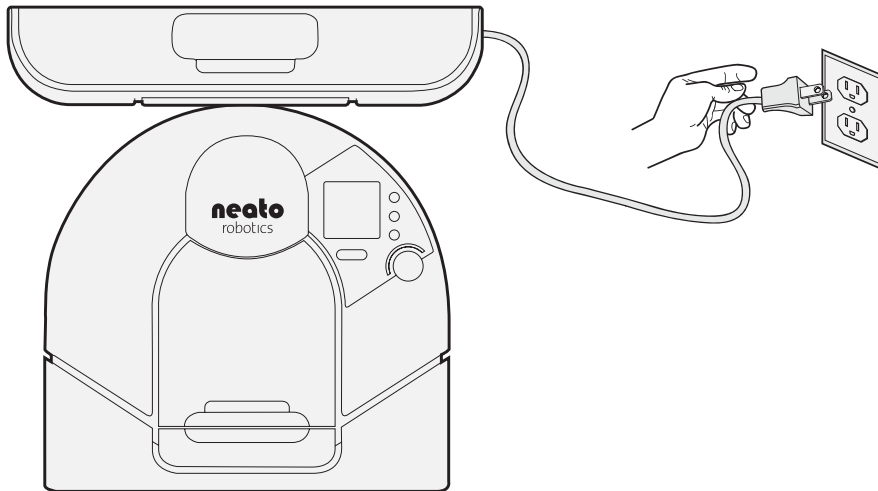

Neato XV-11 connected to charging base

Charging without the Charging Base

Charging without the Charging Base

If you'd rather not use the charging base, follow these steps to use the provided power cable:

- 1 Press the release button to open the back of the charging base and remove the power adapter and cables. Connect the round connector into the power port on the Neato XV-11 and the other end into a three-prong wall outlet as shown below.

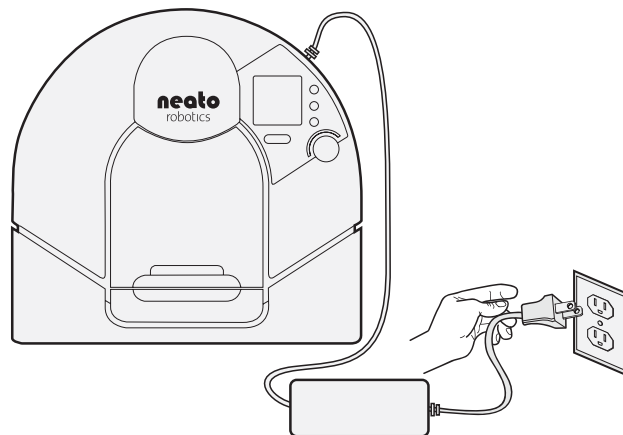

Neato XV-11 charging directly from wall outlet

Charging without the Charging Base

- 2 To reinstall the power adaptor into the charging base, press the release button on top of the charging base to open the back of the unit. As shown in the illustration below, plug the round connector into the receptacle and wrap the cables around the cable wrap pegs. Then extend the cable out of the side of the charging base and plug it into a three-prong wall outlet.

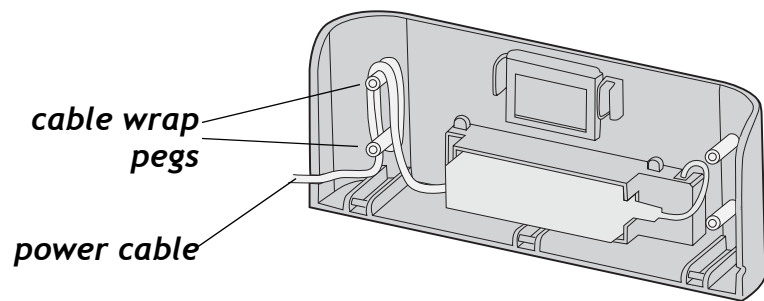

Charging base (internal view)

Charging Status

Recharging the battery takes about 2 to 3 hours. The status light lets you know the current charging state of your Neato XV-11:

Status light color	Meaning
Solid green	Fully charged and ready to clean
Pulsing green	Charging, but ready to clean
Pulsing amber	Charging, can't clean yet
Solid amber	Vacuum has an error (see the LCD screen for details, and refer to <i>Communicating with Your Neato XV-11 Vacuum</i> on page 39)

Optimal Charging

For optimal performance, we recommend that you charge your Neato XV-11 on the charging base whenever it is not cleaning. Not only will this make sure the vacuum will be ready for upcoming cleaning tasks, but it also ensures longer battery life.

Cleaning Mode

Cleaning Mode

Your Neato XV-11 vacuum cleans using its powerful vacuum. Just press the START button and it will vacuum your floors, cleaning them one room at a time and then moving on to clean the next room. It will clean as many rooms as it can on one battery charge. If it is scheduled to clean (see (page 28), your vacuum will clean for one full battery charge, return to base to recharge, and then start cleaning where it left off for one more cleaning session.

Quick-Start Your Robotic Vacuum

The Neato XV-11 works best when it performs regularly scheduled cleanings (see *Scheduling a Cleaning* on page 28), but you can quick-start the vacuum for immediate cleaning any time.

To start the Neato XV-11:

- 1 Charge the vacuum (see *Using the Charging Base* on page 16). The **START** button light is green when the vacuum is fully charged.
- 2 Remove any loose items (such as small toy pieces) that might get caught in the vacuum's brushes.
- 3 Place your Neato XV-11 on the floor.
- 4 Press the **START** button. If the vacuum is asleep, that will wake it up! Then press the button once more to clean your entire house.
- 5 The Neato XV-11 maps the room and cleans it automatically!
- 6 When finished, the vacuum returns to where it started—either to the charging base or to where you manually started it in the room and turns itself off.

Using the Control Center LCD screen

Using the Control Center LCD screen

The Neato XV-11's LCD Control Center screen is your interface to communicate with the vacuum. This is where you give the vacuum its cleaning schedule or pause its cleaning cycle, and it's also where the vacuum will give you information. For example, it may tell you that it is returning to its base to recharge. In addition, if your vacuum encounters a problem, it will tell you what is happening so you can correct the problem.

The Welcome screen looks like this:



The button (called a soft key) below the screen performs the action shown above it on the screen (in this case, **MENU**, which opens the main menu).

Using the Control Center LCD screen

Using this screen, you can:

- Set the clock of the Neato XV-11 (see page 26)
- Program the Neato XV-11 to clean on a scheduled basis (see page 28)
- Get feedback from the vacuum on how it is doing and where it might need some help (see page 39)
- Pause the vacuum (see page 34)
- Turn off the lights on the vacuum (see page 34)
- Turn off power to the vacuum (see page 35)
- Cancel cleaning (see page 34)
- Return the Neato XV-11 to its charging base (see page 34)
- Get support information for Customer Service

Setting the Clock

Setting the Clock

Before you can schedule future cleanings, you must set the current day and time on the vacuum so it knows when to start the next cleaning.

To set the date and time:

1 Press **MENU**.



2 Press the arrow buttons to select **Set Clock** and then press **SELECT**.

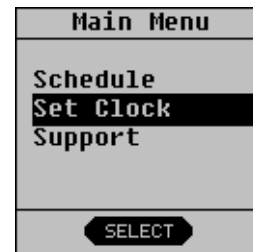

3 Use the arrow buttons to select either **12-Hour Clock** or **24-Hour Clock** and then press **SELECT**.

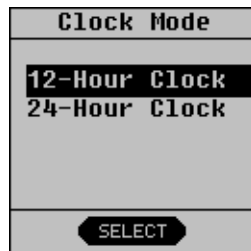

4 Use up and down arrows to select the current day of the week and press **ENTER**.

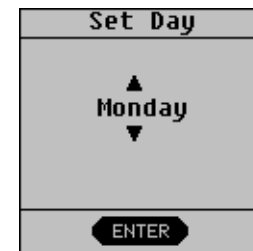

Setting the Clock

- 5** Use the arrow buttons to select the current hour and press **ENTER**. Cycle through the hours to select AM or PM.

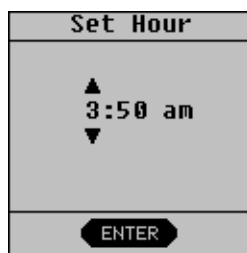

- 6** Use the arrow buttons to select the current minute and press **ENTER**.

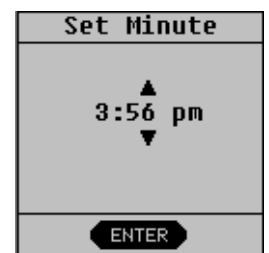

- 7** The current day and time are shown. Press the Back button (⏪) to make corrections; otherwise press **SAVE**.

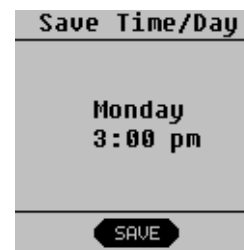

Scheduling a Cleaning

Scheduling a Cleaning

Before setting a schedule, set the clock as described in *Setting the Clock* on page 26.

To schedule a cleaning:

1 Press MENU.



2 Press the arrow buttons to select **Schedule** and then press **SELECT**.



3 Use the arrow buttons to select **Set or Change** and then press **SELECT**.

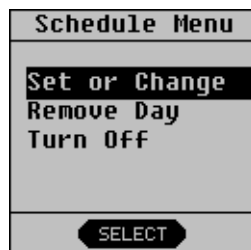

4 Use the arrow buttons to select the day you want your vacuum to clean and press **SELECT**.

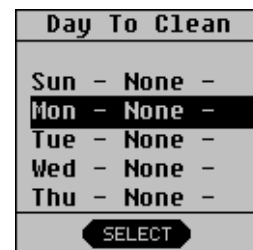

Scheduling a Cleaning

- 5** Use the arrow buttons to select the hour you want your vacuum to clean and then press **SELECT**.

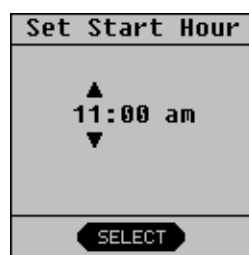

- 6** Use the arrow buttons to select the minute you want your vacuum to clean and then press **SELECT**.

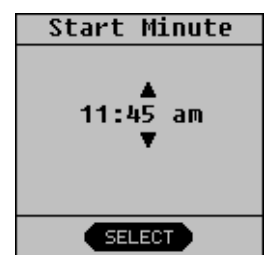

- 7** Confirm the day, time, and cleaning mode by pressing **ADD**. To make changes, press the Back button ⏪.

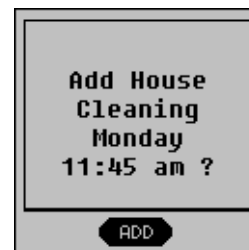

Future cleanings will occur at the times and dates you selected. At each scheduled time, the Neato XV-11 will come off of the charging base and start its scheduled cleaning. When finished cleaning, the vacuum returns to the charging base to recharge. If the battery runs low during the scheduled cleaning, the vacuum returns to its base, recharges, then returns one more time to clean where it left off.

To Get the Most of Scheduled Cleanings

If you are not using the charging base, you will need to put the Neato XV-11 out and it will start its scheduled cleaning when that is the actual time and day of the week. When you return, you will need to manually place the vacuum on its charging base or plug the charger directly into the vacuum.

To Get the Most of Scheduled Cleanings

- Use the charging base so that the Neato XV-11 can automatically go back and recharge itself between cleanings.
- The charging base needs to be located within the area that you want to clean on a schedule.
- Make sure you empty the dirt bin (see *Emptying the Dirt Bin* on page 36) between scheduled cleanings for best results.
- If there is not enough battery power to complete the cleaning cycle, your Neato XV-11 vacuum returns to the charging base to recharge, and then will return to where it left off to finish its cleaning.

Ideas for Scheduled Cleanings

Some ways you can take advantage of scheduled cleanings include:

- Clean a specific high-traffic area on a regular basis. For example, you could set up a schedule to clean your combination kitchen/family room floor once a week at 10 a.m. Using your charging base in the kitchen, the Neato XV-11 comes off its charging base, cleans the room, and returns to the charging base.

Another way to use scheduled cleanings is to keep an everyday schedule. Then, place the Neato XV-11 in different rooms of the house on different days to clean those room at the specified time. You would need to manually put the vacuum back on its base when you get home.

Removing a Scheduled Cleaning

Removing a Scheduled Cleaning

If you need to remove a previously-scheduled cleaning, follow these steps.

1 Press MENU.



2 Press the arrow buttons to select **Schedule** and then press **SELECT**.

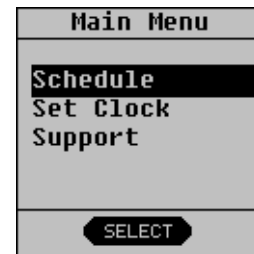

Removing a Scheduled Cleaning

- 3** Use the arrow buttons to select **Remove Day** and then press **SELECT**.

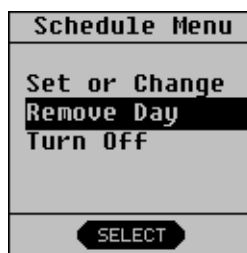

- 4** Use the arrow buttons to choose the cleaning event you want to remove and then press **SELECT**.

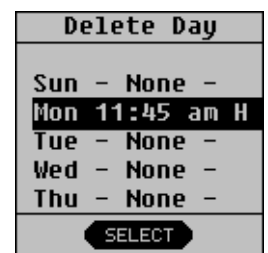

- 5** Press **DELETE** to confirm deletion. Use the Back button \odot if you made a mistake.



- 6** A confirmation message verifies the scheduled cleaning that you removed.

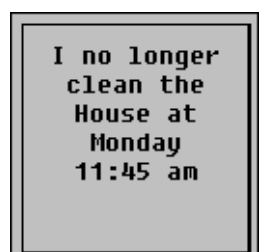

Pausing a Cleaning

Pausing a Cleaning

If at any time you want to pause a cleaning, press any button on the Neato XV-11 and the vacuum will offer you a PAUSE menu. From the PAUSE menu, press the down arrows to make the vacuum:

- Pause its current cleaning
- Cancel its current cleaning
- Cancel and return to its charging base
- Resume its current cleaning

Use the up and down arrows and the SELECT button to tell your Neato XV-11 to do any of the above items.

Turning off the Lights on Your Vacuum

Press and hold the START button for 2 seconds and your Neato XV-11's lights will go off. When the vacuum is turned on the next time, the lights will turn on again.

Turning off Your Vacuum

If you choose to, you can turn off all power to your Neato XV-11. Note that this will delete your clock settings.

To turn off your vacuum:

- 1 Select MENU from the LCD screen.
- 2 Select SUPPORT.
- 3 Select Shut Down.

To power your vacuum once you have done this, just press the START button and it will be fully powered again.

NOTE:Your Neato XV-11 cannot be on its charging base or plugged into the wall when you turn off all power to it.

Emptying the Dirt Bin

Emptying the Dirt Bin

For optimal performance, empty the Neato XV-11's dirt bin after every use.

- 1** Remove the dirt bin.

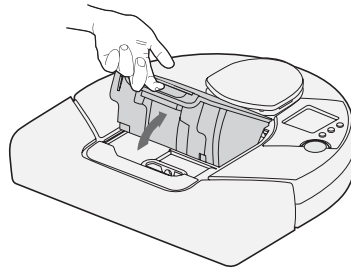

- 2** Remove the cover and filter.

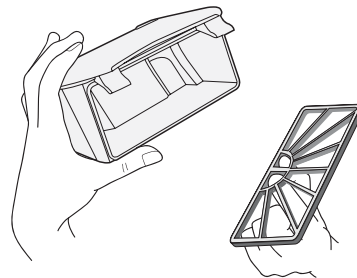

Emptying the Dirt Bin

- 3** Empty the contents of the dirt bin into a garbage can. Tap the filter door and cover against the garbage can to get rid of any excess dirt.

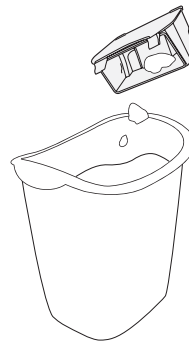

- 4** Replace the filter and dirt bin cover, then replace the dirt bin into the top of the Neato XV-11.

Boundary Markers

Boundary Markers

Boundary Markers are useful tools for your Neato XV-11 vacuum. They tell the vacuum where not to clean.

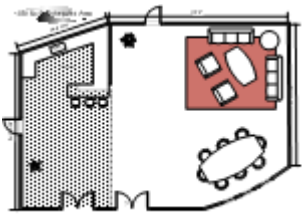

Boundary markers are most helpful when you want to:

- Create a boundary where one does not exist. You might have a large open plan house where you want to clean a subset of a large room like the shaded area shown here.
- Keep your Neato XV-11 vacuum away from any item that you don't want the vacuum to get near.

Using boundary markers

The Boundary Markers come in one 15-foot section. You can use scissors to cut a shorter length if needed.

To use the markers, simply lay the boundary marker across the floor from one wall to the opposite wall to block off an area. The Neato XV-11 will clean the floor on the side of the boundary marker that it is started on. Place the vacuum within the bounded area and press START. The vacuum recognizes the boundary markers and will not cross them.

When finished, the vacuum will return to its charging base or to where it started if it

Communicating with Your Neato XV-11 Vacuum

cannot find its base. (In this case, you will need to start charging the vacuum as soon as you can.)

Communicating with Your Neato XV-11 Vacuum

Communication is a two-way street, so be sure to listen when your Neato XV-11 is talking to you!

When it's charging, the status light around the START button will be GREEN to indicate your Neato XV-11 is ready for work.

If the status light is AMBER, the Neato XV-11 needs some assistance before going to work. Just read the LCD control center screen to see what your vacuum needs assistance with. The vacuum will tell you when to:

- Empty its dirt bin and filter
- Fix its stuck brush
- Unstick its bumper
- Clean its drop sensor windows

...and other feedback too.

LCD Feedback Messages

LCD Feedback Messages

Your vacuum is smart and will let you know when it needs help with anything. Just read the messages on the LCD to understand what it needs. Here are some specific tips.

LCD Message	Remedy
Dirt Bin Full	Empty dirt bin and replace into its slot.
Brush Stuck	Remove brush guard and clean all hair and debris from brush. Replace brush and guard and press START button to resume cleaning.
Bumper Stuck	Jiggle the bumper to loosen.
Brush Slip	Make sure all blades on the brush are in place and not worn down. Make sure the belt is on the end of the brush gear.

LCD Feedback Messages

LCD Message	Remedy
Cannot Charge	Make sure the charging cable is plugged into the base and wall. When vacuum is initially connected to the base, the status light will light up to let you know the power is on.
Battery at Minimum	Place vacuum on charging base to charge.

Filters

Filters

To get the best results, we recommend emptying your dirt bin and cleaning the filter after every vacuum session as described in *Emptying the Dirt Bin* on page 36. To clean your filter, just tap the filter against a garbage can to loosen the debris off of it.

We also recommend changing your filter in your vacuum every 3 months (based on typical usage; if you use your vacuum more frequently, you may need to change your filter more often.)

Your package includes extra filters. You can also purchase additional filters online at <http://www.neatorobotics.com>.

Customer Support

If you have any questions or comments, contact Neato Robotics, Inc.

- Email customer@neatorobotics.com
- Visit www.NeatoRobotics.com for additional support, accessories, and frequently asked questions.
- Call 1-877-29-NEATO to talk to a customer care specialist.

One Year Warranty (Domestic Use)

Your Neato XV-11 vacuum is intended to be used in normal household cleaning, in accordance with the *Neato XV-11 Vacuum User's Guide*.

Limited Warranty

Neato Robotics, Inc. warrants to the original purchaser that your Neato Robotics hardware product shall be free from defects in material and workmanship for the length of time, identified on your product package and/or contained in your user documentation, from the date of purchase. You may also find this information by selecting your product in the Online Support section of our website at <http://www.neatorobotics.com/support>. Except where prohibited by applicable law, this warranty is nontransferable and is limited to the original purchaser. This warranty gives you specific legal rights, and you may also have other rights that vary under local laws.

Neato Robotics, Inc.
1916 Old Middlefield Way Suite A
Mountain View, CA 94043

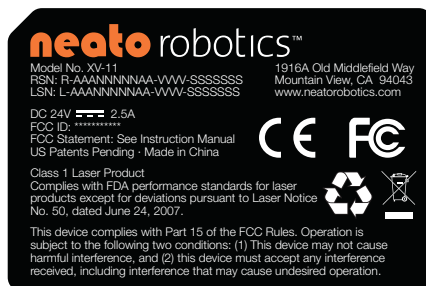

Compliance Information

Room Positioning System: RPS Infrared Laser Distance Sensor

This Laser Product is designated as Class 1 during all procedures of operation.

Human Accessible Laser Parameters:

- Wavelength 785 nm
- Pulse Rep Frequency 1.8 kHz
- Pulse Duration 200 μ sec
- Peak Power 2.1 mW
- Beam Diameter 2.3 mm
- Beam Divergence <5.7 mrad

Caution: Use of controls or adjustments or performance of procedures other than those specified herein may result in hazardous radiation exposure.

Neato Robotics, Inc.
1916 Old Middlefield Way Suite A
Mountain View, CA 94043

No service is allowed by the user. If there are any problems with the RPS laser distance sensor, the robot should be returned to the factory for any service or repair.

Declaration of Conformity

Manufacturer:



Neato Robotics, Inc.
1916 Old Middlefield Way, Suite A
Mountain View, California 94043
United States of America

The directives covered by this declaration:

- 2004/108/EC - Electromagnetic Compatibility (EMC) Directive
- 73/23/EEC - Low Voltage Equipment Directive

The products covered by this declaration:

- XV-11 Robotic Vacuum Appliance (all variations manufactured after January 1, 2010)

The basis on which conformity is being declared:

The manufacturer hereby declares under his sole responsibility that the products identified above comply with the protection requirements of the EMC directive and with the principal elements of the safety objectives of the Low Voltage Equipment directive, and that the following standards have been applied:

Low Voltage Directive:

- EN 60335-1:2002 + A1 + A2 + A11 + A12 + A13
- IEC/EN 60635-2-2:2003 + A1 + A2
- EN 50366:2003 + A1

EMC Directive:

- EN 55014-1:1997 w/A1:2001 and A2:2002
- EN 55014-2:1997
- EN 61000-3-2:2006 (AC Charger)
- EN 61000-3-3:2008 (AC Charger)

The technical documentation required to demonstrate that the products meet the requirements of the Low Voltage Equipment directive has been compiled and is available for inspection by the relevant enforcement authorities. Details of these special measures and limitations to use are available on request. The CE mark was first applied in 2009.



A handwritten signature in blue ink, appearing to read 'Ken Peters', is positioned above the printed name.

Ken Peters
January 30, 2010



According to 47 CFR, Part 15 of the FCC Rules

The following designated product:

EQUIPMENT: Robotic Vacuum

MODEL NO.: XV-11

is a Class B digital device that complies with 47 CFR Parts 2 and 15 of the FCC Rules. Operation is subject to the following two conditions: (1) This device may not cause harmful interference, and (2) this device must accept any interference received, including interference that may cause undesired operation.

A handwritten signature in blue ink, appearing to be 'K. F. ...'.

January 30, 2010

Parts

The following are part numbers and descriptions of items in your package.

Part number	Description
900-0001	Neato XV-11 Robot
945-0007	Neato XV-11 Charging Base w/power adaptor
285-0001	Neato XV-11 Power Adaptor
945-0005	Neato XV-11 Battery Set (package of 2)
945-0009	Neato XV-11 Boundary Markers
500-0001	Neato XV-11 User Guide
515-0001	Neato XV-11 Quick Start Card
945-0004	Neato XV-11 Filter Replacement Package

Disposal Notices

If you ever dispose of your Neato XV-11, follow these steps:

- 1 Unplug the Neato XV-11 from any power source, including removing it from its charging base and removing the power adaptor plug from the Neato XV-11 power connector.
- 2 Unscrew the battery doors (shown in the bottom view illustration on page 8) and unplug and remove the batteries.
- 3 Take the Neato XV-11 to your nearest waste management electronics recycling center.
- 4 Take the batteries to a battery recycling program at your school, place of work, or your nearest waste management battery recycling center.